



GENERAL DESCRIPTION

WPC (Wood Plastic Composite) is a unique composition to replicate wood without the maintenance and hazards of traditional timber decking. 45% timber fibres + 55% HDPE and additives.

PHYSICAL DATA	REQUIREMENTS	TEST RESULT
Hardness	>58HRR	61HRR
Moisture Content	<2%	0.3%
Modulus of Rupture	>20 Mpa	40Mpa
Modulus of Elasticity	>1800 Mpa	3818Mpa
Thickness of Swelling	>1%	0.4%
Size Change – Calefaction	+2.5%	-0.10%
Resistance to Wear	<0.08g/100r	0.077g/100r
Size Change H/L Temp.	+0.2%	-0.10%
Screw Holding Capability	>1000N	3120N
Standard – GB/T 24508-2009 Wood Plastic Composite		
Freeze Thaw Bending Load		
Resistance to Freeze Thaw	>80%	92%
Bending Load	>2500N	3258N

OVERALL TEST RESULTS	
Mean PTV or <i>PTV_{corr}</i> (Dry)	86
Mean PTV or <i>PTV_{corr}</i> (Wet)	42
Slip Potential (Dry)	Low
Slip Potential (Wet)	Low

Slip Test Report

The Decking achieves an anti-slip/low risk surface in dry and wet conditions. A copy of the full Slip Test Report is available upon request.

Warranty

Southgate Plastics Ltd (hereinafter “STORM”) warrants to the original purchaser that, for the period of time set forth in the following sentence, under normal use and service conditions that STORM WPC Decking products shall be free from material defects in workmanship and materials, shall not split, splinter, rot or suffer structural damage from termites or fungal decay. The term of such warranty shall be ten (10) years from the original purchase from STORM (in relation to the Replacement Proportion) and shall be installed and maintained according to the manufacturer’s guidelines.

If a defect occurs within the warranty period, the purchaser must, within ten (10) working days from discovery of the claimed defect but no later than the end of the warranty period, notify STORM in writing at the following email and address:



Southgate Plastics Ltd
Southgate House
Unit 9 Robins Drive
Castlefields Industrial Estate
Bridgwater
Somerset
TA6 4DL

Email: info@stormbuildingproducts.com

The Purchaser must include in this notification proof of purchase along with statement and photos explaining the defect and the date the products were installed. STORM may request additional information to assist with any necessary investigation. After reviewing all information and upon completion of an investigation, STORM shall make a determination with respect to the validity of such a claim. If STORM confirms the Purchaser's claim is valid, STORM's sole responsibility shall be to either replace the defective products or refund the portion of the purchase price paid by the Purchaser for any such defective products.

Other Costs

This warranty shall not cover and STORM shall not be responsible for costs and expenses incurred with respect to the removal of defective STORM WPC Decking products or the installation of replacement materials, including but not limited to labour and freight. STORM shall have no further liability of obligation except as expressly stated herein. Under no circumstances with STORM be liable for special, incidental or consequential damages, whether such damages are sought in contract, in tort (including but not limited to negligence and strict liability) or otherwise, and STORM's liability with respect to defective STORM WPC Decking products shall in no event exceed the replacement of such products or refund of the purchase price, as described above.

Replacement Proportion

After the original purchase date, the Purchaser's recovery shall be prorated in the following manner:

Year of Claim	Replacement Ratio (%)
1 – 3	100%
4 – 5	70%
6 – 7	50%
8 – 9	30%
10 +	10%

Exclusions

STORM does not warrant against and is not responsible for, and no implied warranty shall be deemed to cover, any condition attributed to:

1. Installation of STORM WPC Decking products and/or failure to avoid by STORM's installation guidelines, including but not limited to gapping;
2. Use of STORM's WPC Decking products beyond normal use and service conditions, or in an application not recommended by STORM's guidelines and local codes;
3. Movement, distortion, collapse or setting of the ground the supporting structure on which STORM's WPC Decking products are installed;
4. Any act of God (such as, but not limited to, flooding, hurricane, earthquake, thunder and lightning, etc), environmental conditions (such as, but not limited to, air pollution, mould, mildew, etc), staining from foreign substances (such as, but not limited to, dirt, grease, oil, etc) or normal weathering;
5. Slight variations or changes in colour of STORM's WPC Decking products;
6. Handling, storage, abuse or neglect of STORM's WPC Decking products by purchaser;
7. Decay caused by fasteners;
8. Ordinary wear and tear.

This warranty may not be altered or amended except in a written instruction signed by STORM and the Purchaser. No person or entity is authorised by STORM to make and STORM shall not be bound by any statement or representation as to the quality or performance of STORM's WPC Decking products other than contained in this warranty.

Profile Drawings

WPC DF Deck Board

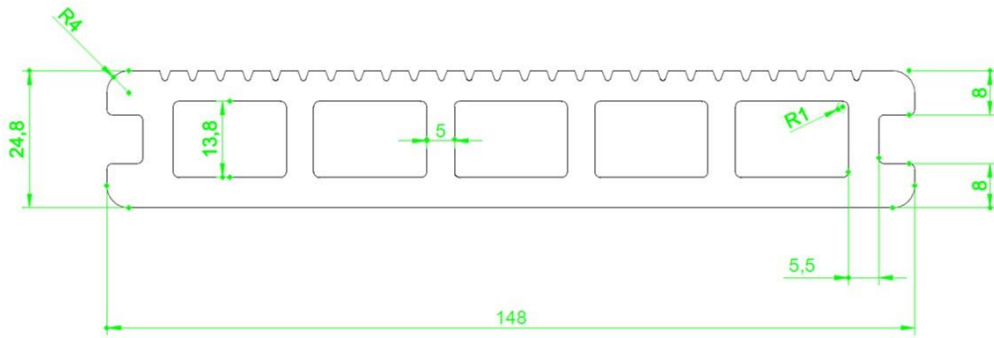

WPC DF Angle Trim

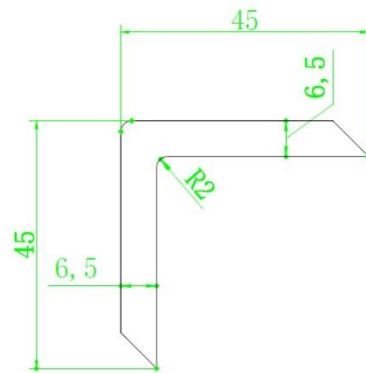

WPC DF Step Board

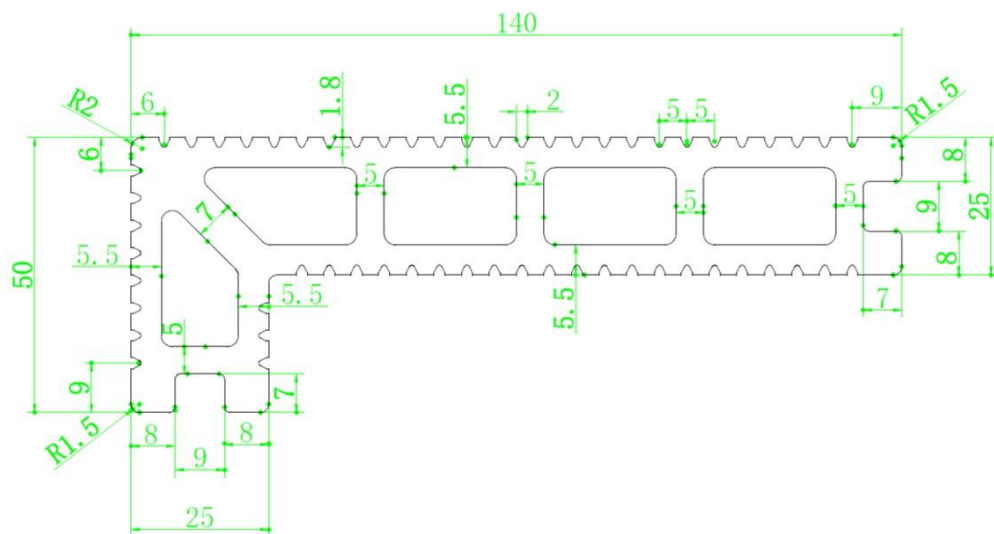

WPC DF Subframe

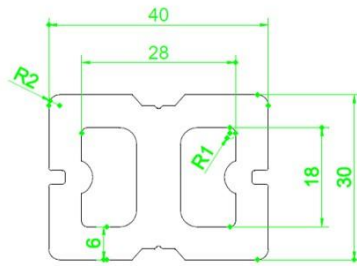

PVC Fixing Clip

31mm (long) x 18mm (wide) x 11mm (thick)

Intermediate S/S Clip

36mm (long) x 40mm (wide) x 11mm (thick)

Starter S/S Clip

27mm (long) x 24mm (wide) x 10mm (thick)

Important Installation Instructions

- Slight colour and surface differences may occur due to slight differences in raw materials or surface treatment. The Deck boards will fade by 10% of the colour over the first 12-month period of being installed. At the end of this period the surface colour will stabilise.
- It is advisable to place the Deck boards in the required installation site for 72 hours before you start the installation for them to acclimatize. The decking should not be installed in temperatures below 5°.
- We advise to use original accessories and parts from STORM to ensure warranty remains valid.
- There must be a space of at least 25mm between the ground and the substructure. In case of insufficient ventilation any warranty will be invalidated. There should not be direct contact between the decking structure and the ground (grass, soil etc.)
- Variations in temperature and moisture uptake will result in expansion (about 0.3% to 0.5).
- A strong and compacted base such as concrete is recommended.
- WPC product is not suitable for closed and moist environments such as sauna rooms etc.

Installation

Prepare the substructure

- Ensure there is sufficient drainage below the deck area.
- Lay the sub frame with a slight gradient of 1% to 1.5% away from the walls, laid lengthwise. Keep the sub frame set of any surrounding walls or other obstacles to allow for slight expansion.
- Keep the Substructure at maximum 400mm centres.
- The Substructure should be fixed by expansion screws to the concrete at a distance of 30-40cm.
- To ensure each deck board has a full bearing each end, for runs lower than 5m, the subframe should overlap by a minimum of 100mm.
- If deck boards have to be joined on the length, a second section of Joist should be added.

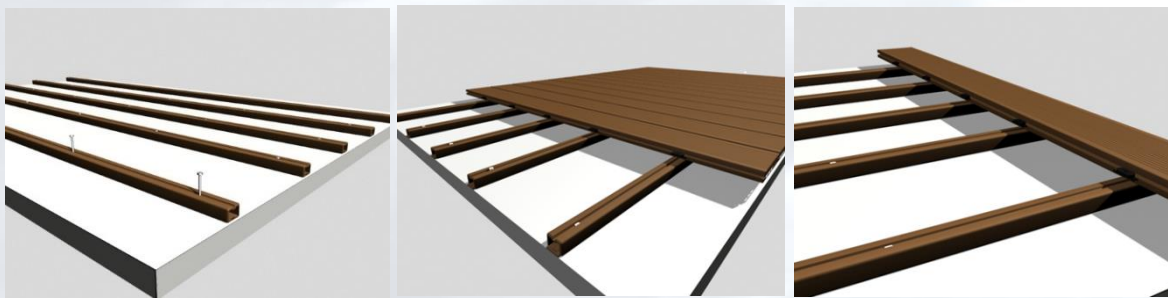

The WPC products' expansion rate is around 0.3% to 0.5% depends on different weather condition in different places, based on this expansion rate, there must always be a gap always between 2 WPC products, as follows:

- The distance of at least 30mm from walls or other obstacles to allow for expansion of the deck boards.
- Allow at least a 10mm gap on butt joints.
- **IMPORTANT:** when fixing the starting clips or the connecting clips, we recommend pre-drilling with a 2.5mm drill bit to prevent cracking or breaking the sub frame as WPC products have a high density.

Finishing

- There must be a gap at the joint between two corner covers, calculated based on the expansion rate 0.3-0.5% of the length.
- The distance between the fixing screws have to be maximum 300mm.
- When fitting the matching angle trim, you can use STORMfix, a one part solvent free hybrid adhesive with a very high initial grab and no slip properties.

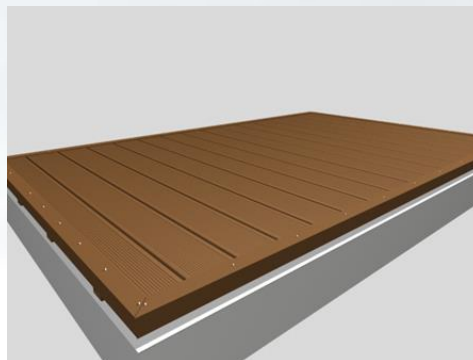
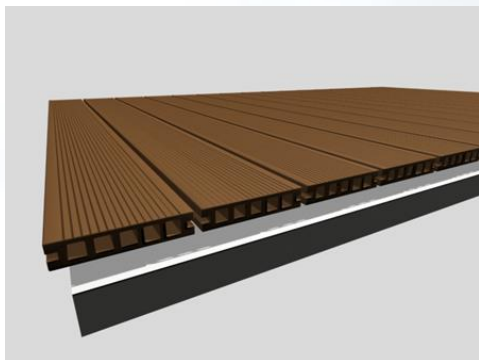

Expansion & Fading

The deck area can be finished with the angle trim around the perimeter, this provides a neat finish to the deck. Allow the same expansion tolerances as the decking.

Maintenance

Stains

Water stain marks can show on any composite decking boards. There are 2 main types of water stains; both of which will generally disappear with exposure to general weathering.

1. Water stains from wood tannins will occur in the early life of your deck as the natural tannins come out of the wood fibres at the surface of the composite decking. This will happen in the early weeks of your deck being laid, and will depend on how exposed to the elements your deck is before the weathering process is complete. This type of stain can be more prominent when new decking is exposed to direct sunshine in the first few months of its life.
2. Water stains from water pooling or dripping can happen on composite decking just like it can with many other materials/surfaces such as timber decking, glass, laminated flooring etc. This can leave a "shoreline" effect. The visibility of the stain will be governed by factors such as how dirty the deck is and how quickly the water dries from the water pooling, clean as mentioned below. Again, this can be exaggerated in hotter weather.

Both types of marks/stains will disappear naturally over time unless, of course, you have a recurring problem that allows water to continually land on to the composite decking. E.G. a drip from the gutter will continue to make marks until water is stopped from landing on the water stained area.

Oil and cigarette stains etc can be very difficult to remove from the surface, avoid contact at all times.

We advise is to let the composite decking weather naturally over time. However, we understand you want to be proud of your new deck once installed and if you feel the need to try and remove the marks yourself then wash with clean, hot water, this should wash away. Do not wash your decking whilst it is still hot from a day's sunshine.

1. Pour clean, hot water on the deck and let it sit for 5-10 minutes
2. Work in with a soft bristle brush
3. Pressure wash (at low pressure and wide fan) / rinse down in hot water (preferred)
4. Squeegee water off the deck with a squeegee brush
5. Mop up any wet areas with a clean sponge mop

If water marks have been long standing they may require more hot water or repeated procedure.

IMPORTANT: Never use strong detergent or bleach based products.

Colour Difference

Sometimes you may see a colour difference in the composite decking boards, as they are produced in batches using natural products, and therefore no way to prevent this from happening. Boards will weather over time.

If the boards are similar colour, over time they should weather down and will likely end up a very similar colour.

Important Notice

Data contained in this document is for information only and is believed to be reliable. Southgate Plastics cannot assume responsibility for results obtained by others over whose methods we have no control. It is the user's responsibility to determine suitability of the product for any specific purpose and we are pleased to provide a sample upon request.

Frequently Asked Questions (FAQ)

What is WPC Double Faced Decking?

Wood Plastic Composite (WPC) Double Faced Decking is a revolutionary decking with a unique composition to replicate wood without the maintenance and hazards of the traditional timber deck.

What is WPC Double Faced Decking used for?

WPC Double Faced Decking is used to provide a maintenance free outside area for the whole family to enjoy.

What is the best thing about WPC Double Faced Decking?

The best thing about WPC Double Faced Decking is that it is safe, easy to install, maintenance free and environmentally friendly.

Why should end users use STORM's WPC Double Faced Decking?

It offers a 10 year guarantee as well as offering 5 different colours, 2 designs and 2 lengths as well as a range of accessories.

Who are the type of customers that commonly use WPC Double Faced Decking (which industries/sectors/job types?)

Builders, maintenance companies, landscapers and DIY are the types of people that would commonly use WPC Decking.

Where is WPC Double Faced Decking most commonly installed?

WPC Double Faced Decking would most commonly be installed in private homes, parks, recreations centres, caravan and camping sites.

When should WPC Double Faced Decking be considered? When should it be installed?

WPC Double Faced Decking should be considered when upgrading and renovating, installing new decking areas or creating extra clean, dry areas. WPC Decking can be installed anytime of the year but would advise during the spring to autumn period due to generally finer weather conditions. Decking shouldn't be installed in temperatures lower than 5°.