



# TRITON WPC DECKING

PRODUCT BROCHURE



**The double-faced and  
low-maintenance alternative  
to traditional timber decking**



For more information or technical advice, call our team on 01278 455326



## INTRODUCING TRITON WPC DECKING

STORM TRITON WPC decking is the low-maintenance alternative to traditional timber decking. The decking has an exceptionally robust surface and provides high standards of weather resistance. TRITON decking is the right choice for any environment or application and is designed for performance.

**For more information about our TRITON WPC decking, call 01278 455326 or email [sales@stormbuildingproducts.com](mailto:sales@stormbuildingproducts.com).**

**Note:** Images and colours shown in this brochure are for illustrative purposes only as printing does not allow 100% accuracy transfer for true colour to be reproduced.

### The benefits of TRITON WPC decking



10-year warranty



Anti-slip surface



Easy installation



Eco-friendly and environmentally friendly



Does not accommodate algae growth

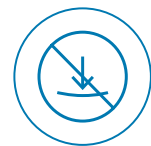

Does not rot, splinter or warp



# ONE BOARD. TWO DESIGNS

One side of the TRITON WPC decking has a deep and realistic wood pattern that is created using a process that aims to replicate a natural finish as closely as possible. The other side has a regular groove pattern that provides a more traditional style. The design of the grooved side is a great option for a border or steps around your deck.

Both surfaces have a specially processed finish and anti-slip surface.

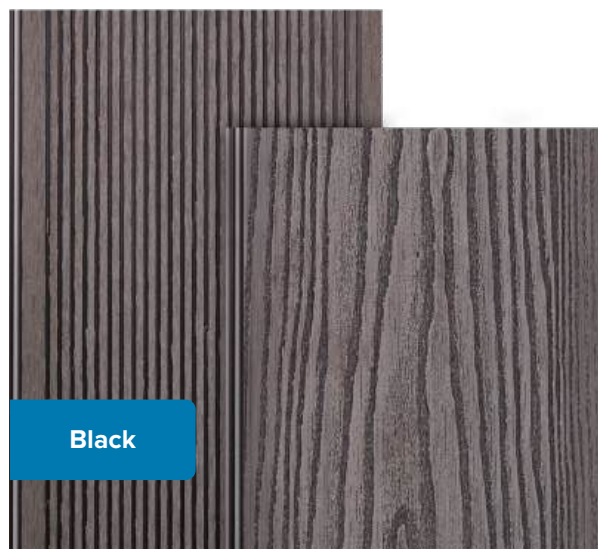
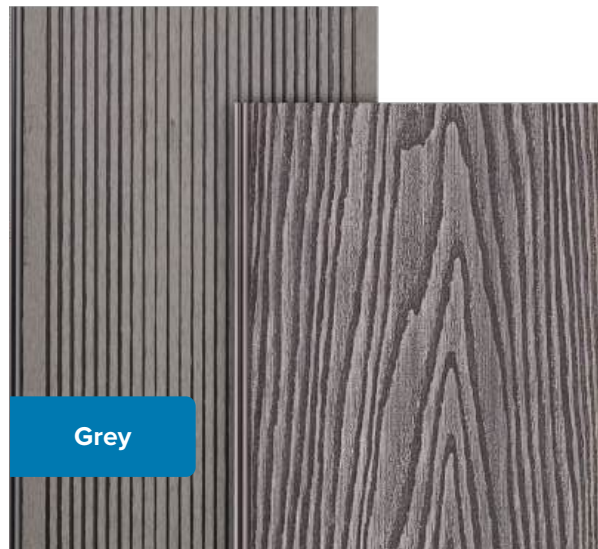
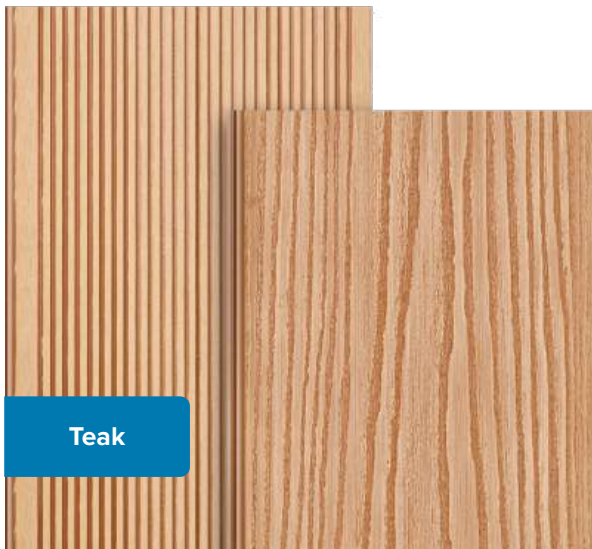

# COMPONENTS DIAGRAM



Deck Board



Angle Trim



Subframe

**Note:** Use plastic fixing clips or stainless steel clips. Starter clips need to be used on all installations.



Plastic Fixing Clip



S/S Intermediate Clip



S/S Starter Clip

# COMPONENTS LIST

## TRITON WPC Decking Boards

Code	Size (mm)	Colour	Quantity
WPCDF30-BK	3000 x 148 x 25	Black	1
WPCDF30-BN	3000 x 148 x 25	Brown	1
WPCDF30-NL	3000 x 148 x 25	Natural	1
WPCDF30-GY	3000 x 148 x 25	Grey	1
WPCDF30-TK	3000 x 148 x 25	Teak	1
WPCDF50-BK	5000 x 148 x 25	Black	1
WPCDF50-BN	5000 x 148 x 25	Brown	1
WPCDF50-NL	5000 x 148 x 25	Natural	1
WPCDF50-GY	5000 x 148 x 25	Grey	1
WPCDF50-TK	5000 x 148 x 25	Teak	1

## TRITON WPC Subframe

Code	Size (mm)	Colour	Quantity
WPCDF50-SUB	5000 x 40 x 30	Black	1

## TRITON WPC Angle Trim

Code	Size (mm)	Colour	Quantity
WPCDF30-AT-BK	3000 x 45 x 45	Black	1
WPCDF30-AT-BN	3000 x 45 x 45	Brown	1
WPCDF30-AT-NL	3000 x 45 x 45	Natural	1
WPCDF30-AT-GY	3000 x 45 x 45	Grey	1
WPCDF30-AT-TK	3000 x 45 x 45	Teak	1
WPCDF50-AT-BK	5000 x 45 x 45	Black	1
WPCDF50-AT-BN	5000 x 45 x 45	Brown	1
WPCDF50-AT-NL	5000 x 45 x 45	Natural	1
WPCDF50-AT-GY	5000 x 45 x 45	Grey	1
WPCDF50-AT-TK	5000 x 45 x 45	Teak	1

**Note:** The angle trim colour will not exactly match the wood grain side; this is due to the surface texture differences. The debossed nature and depth of the wood grain finish naturally creates a shadow effect. The smooth surface of the angle trim will match more closely with the grooved side of the decking.

# COMPONENTS LIST

## TRITON WPC Step Board

Code	Size (mm)	Colour	Quantity
WPCSST-30-SP-BK	3000 x 140 x 50 x 25	Black	1
WPCSST-30-SP-BN	3000 x 140 x 50 x 25	Brown	1
WPCSST-30-SP-NL	3000 x 140 x 50 x 25	Natural	1
WPCSST-30-SP-GY	3000 x 140 x 50 x 25	Grey	1
WPCSST-30-SP-TK	3000 x 140 x 50 x 25	Teak	1

**Note:** Step boards are grooved design only.

## Clips

Code	Description	Colour	Quantity
WPCSST-CLIPPK	WPC SST Fixings	Stainless Steel/PVC	100
WPCSST-SS-CLIPPK	WPC Intermediate Clips	Stainless Steel	100
WPCSST-ST-CLIPPK	WPC Starter Clips	Stainless Steel	20

## Clip System Details

### Standard plastic fixing clip (WPCSST-CLIPPK):

- Allows deck boards to be removed easily without uninstalling the complete deck
- Creates an 8 mm gap between the deck boards
- Includes a stainless steel screw

### Stainless steel intermediate clip (WPCSST-SS-CLIPPK):

- Hidden fixing design - 4 mm gap between the boards
- Complete stainless steel body and screw



# PROFILE DRAWINGS

## Deck Board

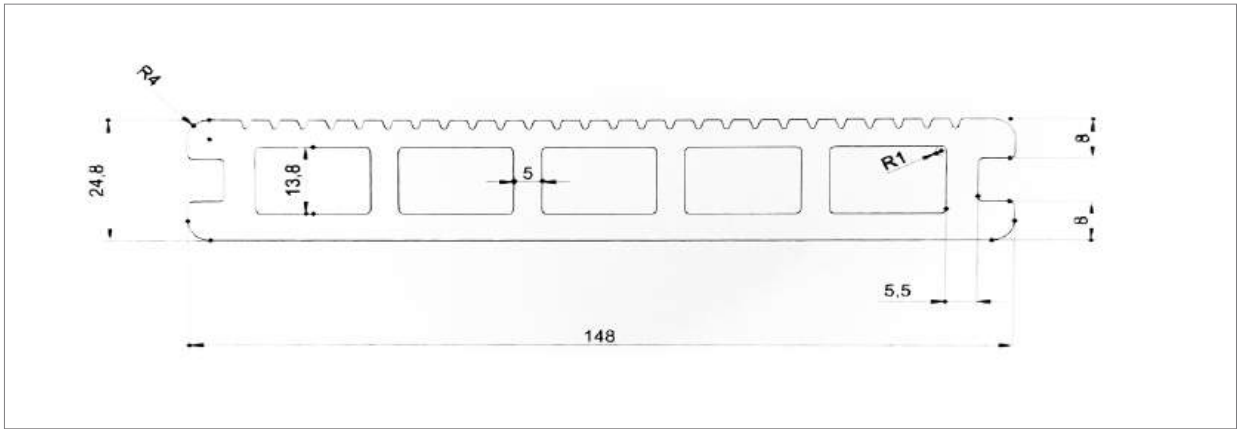

## Step Board

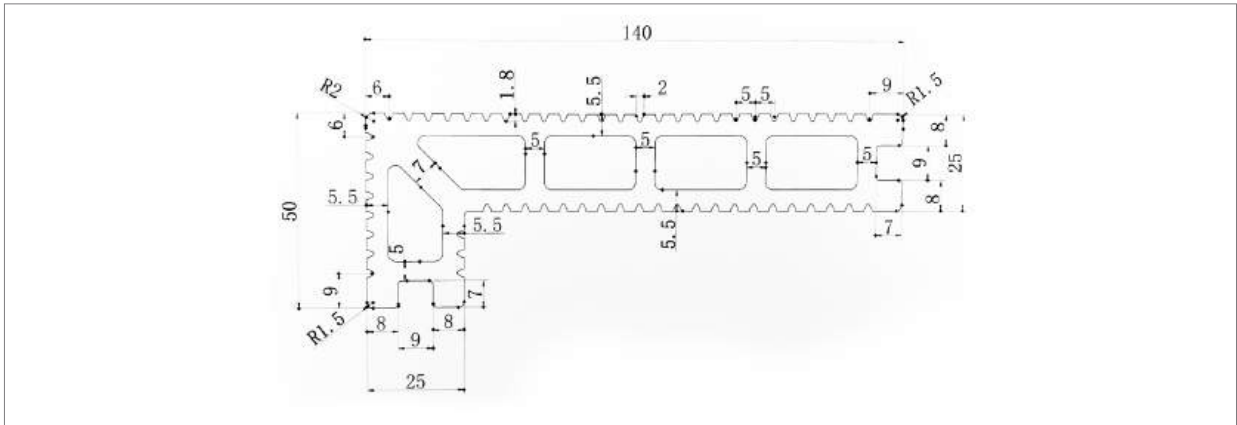

## Angle Trim

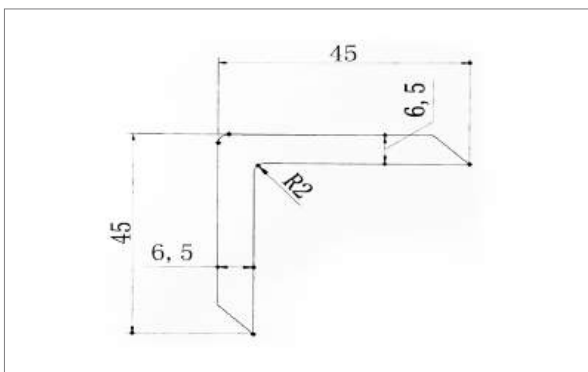

## Subframe

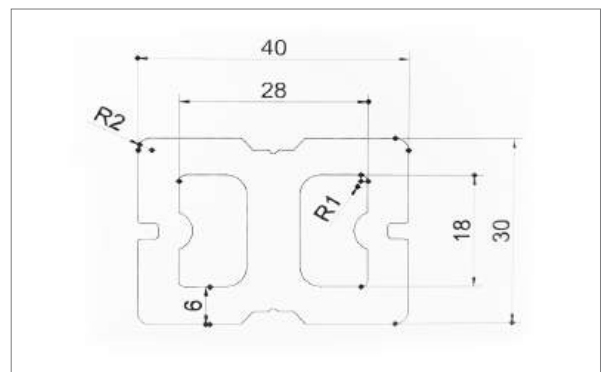

Product Name	Dimensions (Length x Width x Thickness)
PVC Clip	31 x 18 x 11 mm
Starter S/S Clip	27 x 24 x 10 mm
Intermediate S/S Clip	36 x 40 x 11 mm

**Note:** All dimensions are to give an indication only. They do not allow for production tolerances. They should only be used to give approximate quantities when working out the deck area.



# DATA SHEET

Physical Data	Requirements	Test Results
Hardness	>58HRR	61HRR
Moisture Content	<2%	0.3%
Modulus of Rupture	>20 Mpa	40 Mpa
Modulus of Elasticity	>1800 Mpa	3818 Mpa
Thickness of Swelling	>1%	0.4%
Size Change - Calefaction	+2.5%	-0.10%
Resistance to Wear	<0.08g/100r	0.077g/100r
Size Change H/L Temp.	+0.2%	-0.10%
Screw Holding Capability	>1000N	3120N
<b>Standard - GB/T 24508-2009 Wood-Plastic Composite</b>		
Freeze-Thaw Bending Load		
Resistance to Freeze-Thaw	>80%	92%
Bending Load	>2500N	3258N

Overall Test Results	
Mean PTV or PTV <sub>corr</sub> (Dry)	86
Mean PTV or PTV <sub>corr</sub> (Wet)	42
Slip Potential (Dry)	Low
Slip Potential (Wet)	Low

## Slip Test Report

The decking achieves an anti-slip/low-risk surface in dry and wet conditions. A copy of the full slip-test report is available upon request.

## B1 Fire Rating

# WEED PROTECTION MEMBRANE

**STORM Weed Protection Membrane is a standard-duty non-woven weed control fabric that offers effective weed suppression for many different outdoor applications.**

Weed Protection Membrane prevents weeds getting the daylight they need to grow, helping to protect your decking. It is ideal for use beneath garden decking and decorative borders. It is lightweight, easily unrolled and cut using safety knives or scissors.

Product Code	Product Description	Width	Length
GRASS-WEEDCONTROL	Weed Control Fabric Roll	2 m	25 m

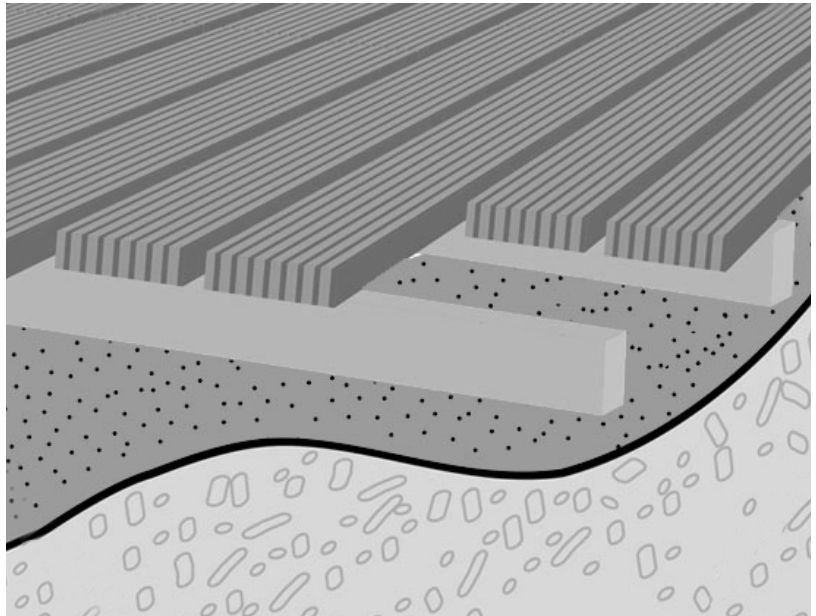



## INSTALLING TRITON WPC DECKING

### Important installation instructions

- Slight colour and surface deviation may occur due to slight differences in raw materials or surface treatment. The deck boards will fade over the first 12 months of being installed. At the end of this period, the surface colour will stabilise. The degree of fading will depend on the location of the decking and the resulting exposure to bright sunlight and weather conditions.
- It is advised to place the deck boards in the required installation site for 72 hours before you start the installation for them to acclimatise. The decking should not be installed in temperatures below 5°C.
- We advise using original accessories and components from STORM to ensure the warranty remains valid.
- In case of insufficient ventilation, any warranty will be invalidated. There should not be direct contact between the decking structure and the ground (grass, soil etc.).
- Variations in temperature and moisture uptake will result in expansion.
- A strong and compacted base such as concrete is recommended.
- WPC decking is not suitable for closed and moist environments such as sauna rooms etc.





## STEP 01 PREPARE THE SUBSTRUCTURE

Ensure there is sufficient drainage below the deck area.

Lay the subframe with a slight gradient of 1% to 1.5% away from the walls. It should also be laid lengthways. Keep the subframe set off any surrounding walls or other obstacles to allow for slight expansion.

Keep the substructure at a maximum of 350 mm centres.

Fixing clips must be installed to every joist/subframe.

The substructure should be fixed by expansion screws to the concrete at a distance of 300-400 mm.

Where the decking needs to be joined longitudinally, we recommend having a double bearer to provide sufficient support for both ends of the deck boards.

Subframes or joists should be doubled up wherever there are butt joints, in order to ensure that each board end is fully supported and is held by a complete clip.

---

## STEP 02 INSTALLING AND EXPANDING

The expansion rate of TRITON WPC decking can vary depending on different weather conditions. Based on this expansion rate, there must always be a gap between two TRITON WPC decking boards as follows:

- Allow at least a 8 mm gap on butt joints.
- The distance of at least 15 mm from walls or other obstacles to allow for expansion of the deck boards.

**Important: When fixing the starter clips or intermediate clips, we recommend pre-drilling with a 2.5 mm drill bit to prevent cracking or breaking the subframe as WPC products have a high density.**

The deck area can be finished with the angle trim product around the perimeter; this provides a neat finish to the deck. Allow the same expansion tolerances as the decking.

When fitting the matching angle trim, you can use STORMFix, a one-part solvent-free hybrid adhesive with high initial grab and no-slip properties. Angle trims must not be screwed down as they need to be free to expand and contract.



## STEP 03 MAINTENANCE AND AFTERCARE

Water stain marks can show on composite deck boards. The main types of water stains will generally disappear with exposure to general weathering.

Water stains from wood tannins will occur in the early life of your deck as the natural tannins come out of the wood fibres at the surface of the composite decking. This will happen in the early weeks of your deck being laid and will depend on how exposed to the elements your deck is before the weathering process is complete. This type of stain can be more prominent when new decking is exposed to direct sunlight in the first few months of its life.

Water stains from water pooling or dripping can leave a “shoreline” effect. The visibility of the stain depends on variables like how dirty the decking is and how quickly the water dries from the water pooling. Again, this can be exaggerated in hotter weather.

Both types of marks/stains will disappear over time unless you have a recurring problem that continually allows water to land on the composite decking, e.g. a drip from the gutter will continue to make marks. Oil or cigarette stains etc. can be very difficult to remove from the surface, so avoid contact.

We advise letting the composite decking weather naturally over time. However, we understand you want to be proud of your new deck once installed, and if you feel the need to try and remove the marks yourself, washing with clean, hot water should wash away most. Don't wash your decking whilst it is still hot from a day's sunshine.

1. Pour clean, hot water on the deck and let it sit for 5-10 minutes.
2. Work in with a soft bristle brush.
3. Pressure wash (at low pressure and wide fan) or rinse down in hot water (preferred option).
4. Push the water off the deck with a squeegee brush.
5. Mop up any wet areas with a clean sponge mop.

Watermarks may require more hot water or repeated procedure if they are long-standing.

**Important: Never use strong detergent or bleach-based products.**

**Please note: The warranty does not cover variation or changes in the colour of the TRITON WPC decking. See overleaf for more warranty details.**

# WARRANTY

Southgate Plastics Ltd (hereinafter “STORM”) warrants to the original purchaser that, for the period of time set forth in the following sentence, under normal use and service conditions that STORM WPC decking products shall be free from material defects in workmanship and materials, shall not split, splinter, rot or suffer structural damage from termites or fungal decay. The term of such warranty shall be ten (10) years from the original purchase from STORM (in relation to the Replacement Proportion) and shall be installed and maintained according to the manufacturer’s guidelines.

If a defect occurs within the warranty period, the purchaser must, within ten (10) working days from discovery of the defect but no later than the end of warranty period, notify STORM in writing at the following email and address: sales@stormbuildingproducts.com Southgate Plastics Ltd, Southgate House, Robins Drive, Bridgwater, Somerset TA6 4DL

The Purchaser must include proof of purchase along with statement and photos explaining the defect and the date the products were installed in this notification. STORM may request additional information to assist any necessary investigation. After reviewing all information and upon completion of an investigation, STORM shall make a determination with respect to the validity of such a claim. If STORM confirms the Purchaser’s claim as valid, STORM’s sole responsibility shall be to either replace the defective products or refund the portion of the purchase price paid by the Purchaser for any defective products.

## Other Costs

This warranty shall not cover and STORM shall not be responsible for costs and expenses incurred with respect to the removal of defective STORM WPC decking products or the installation of replacement materials, including but not limited by labour and freight. STORM shall have no further liability of obligation except as expressly stated herein. Under no circumstances will STORM be liable for special, incidental or consequential damages, whether such damages are sought in contract, in tort (including but not limited to negligence and strict liability) or otherwise, and STORM’s liability with respect to defective STORM WPC decking products shall in no event exceed the replacement of such products or refund the purchase price, as described.

## Exclusions

STORM does not warrant against and is not responsible for, and no implied warranty shall be deemed to cover, any condition attributable to:

1. Installation of STORM WPC decking products and/or failure to avoid by STORM’s installation guidelines, including but not limited to gapping.
2. Use of STORM WPC decking products beyond normal use and service conditions, or in an application not recommended by STORM guidelines and local codes.
3. Movement, distortion, collapse or setting of the ground the supporting structure on which STORM WPC decking is installed.
4. Any act of God (such as, but not limited to, flooding, hurricane, earthquake, thunder and lightning, etc.), environmental conditions (such as, but not limited to, dirt grease, oil, etc.) or normal weathering.
5. Fading or changes in colour of STORM WPC decking products.
6. Handling, storage, abuse or neglect of STORM WPC decking products by Purchaser.
7. Decay caused by fasteners.
8. Ordinary wear and tear.

This warranty may not be altered or amended except in a written instruction signed by STORM and the Purchaser. No person or entity is authorised by STORM to make; and STORM shall not be bound by any statement or representation as to the quality or performance of STORM WPC decking products other than contained in this warranty.

## Replacement Proportion

After the original purchase date, the Purchaser’s recovery shall be prorated in the following manner:

Year of Claim	Replacement Ratio (%)
1-3	100%
4-5	70%
6-7	50%
8-9	30%
10+	10%

Storm® and STORM Building Products is a trade mark belonging to Southgate Plastics Limited.





## FREQUENTLY ASKED QUESTIONS

### **What is WPC decking?**

Wood-plastic composite (WPC) decking is a revolutionary decking with a unique composition that replicates wood without the maintenance or hazards of the traditional timber deck.

### **What is WPC decking used for?**

WPC decking is used to provide a low-maintenance outside area for residential applications that everyone can enjoy.

### **What is the best thing about WPC decking?**

The best thing about WPC decking is that it is safe, easy to install and low-maintenance.

### **What type of customers commonly use WPC decking?**

Builders, maintenance companies, landscapers and DIY people would commonly use WPC decking.

### **Where is WPC decking most commonly installed?**

WPC decking would most commonly be installed in private homes, caravan and camping sites and balconies.

### **When should WPC decking be considered? When should it be installed?**

Strongly recommended in residential properties only, WPC decking should be considered when upgrading, renovating or installing exterior spaces where a decking is appropriate. WPC decking can be installed at any time of the year, but it is advised to install between spring and autumn due to generally finer weather conditions. Decking should not be installed in temperatures lower than 5°C.

### **What are the eco-credentials of WPC decking?**

TRITON WPC decking has Forest Stewardship Council certification (FSC), meaning the wood used in TRITON decking is from sustainable sources. Becoming FSC certified shows that the decking complies with the highest social and environmental standards on the market.



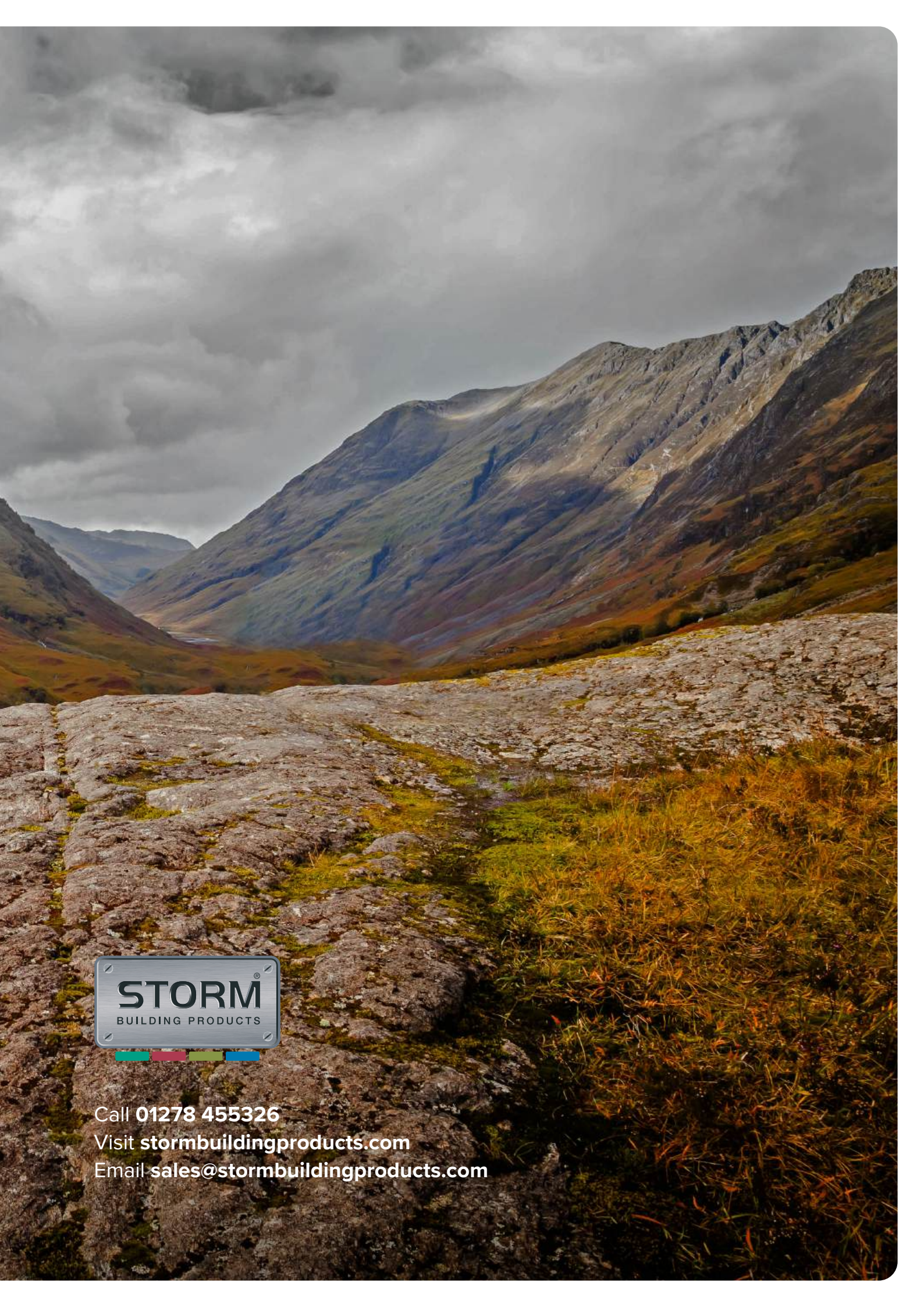

Call **01278 455326**

Visit **[stormbuildingproducts.com](http://stormbuildingproducts.com)**

Email **[sales@stormbuildingproducts.com](mailto:sales@stormbuildingproducts.com)**